

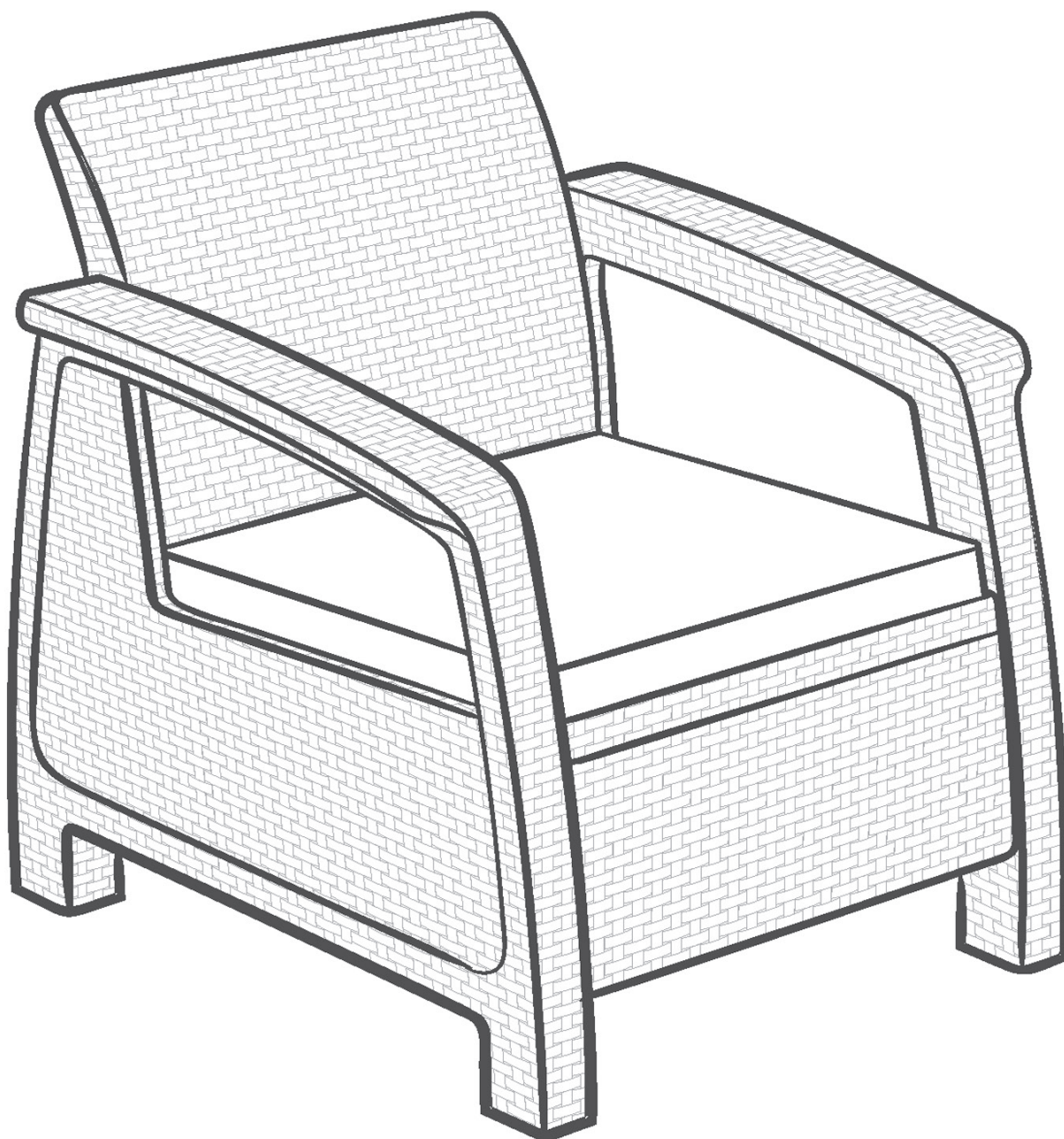

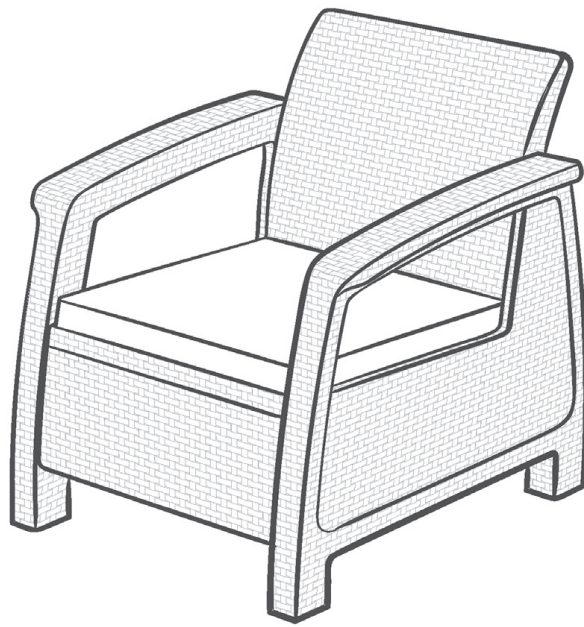

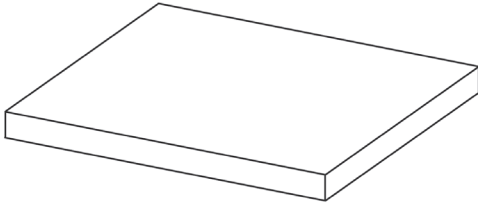

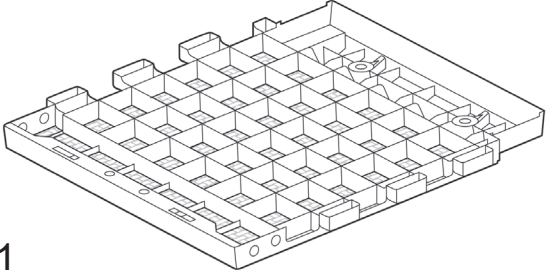

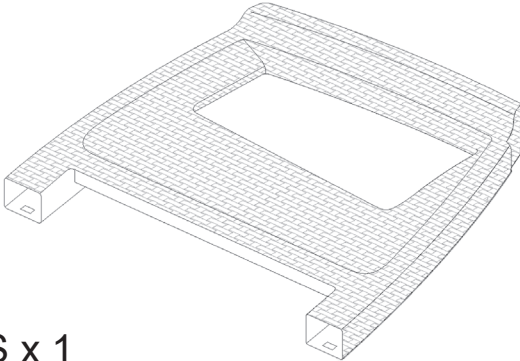
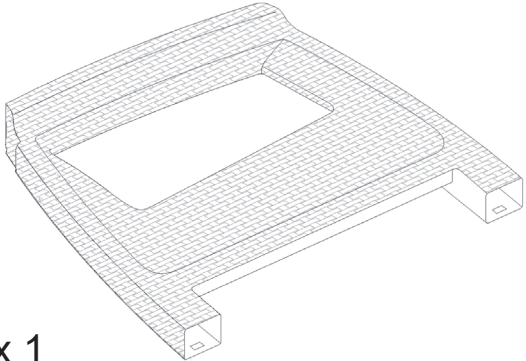
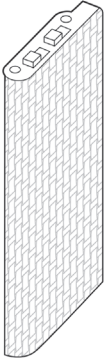
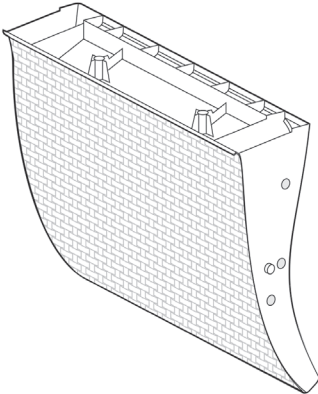

OCO KIP



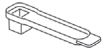

 <p>x 1</p>	 <p>S x 1</p>								
 <p>LS x 1</p>	 <p>RS x 1</p>								
 <p>FB x 2</p>	 <p>B x 1</p>								
 <p>L1 x 1</p>	 <p>L2 x 1</p>	 <p>L3 x 1</p>	 <p>L4 x 1</p>	 <p>x 16</p>	 <p>LP x 4</p>	 <p>SP x 12</p>	 <p>L x 1</p>	 <p>R x 1</p>	

1

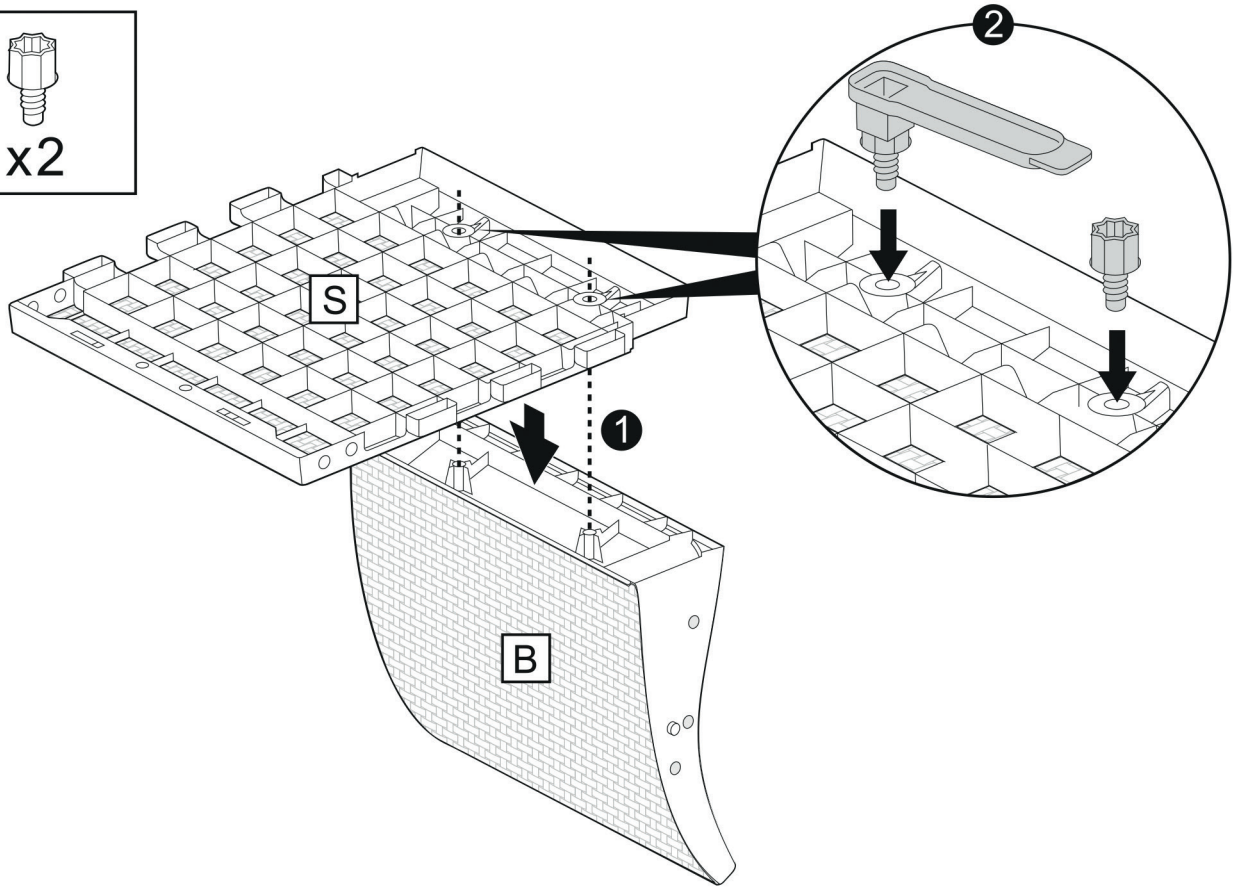
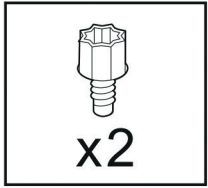

2

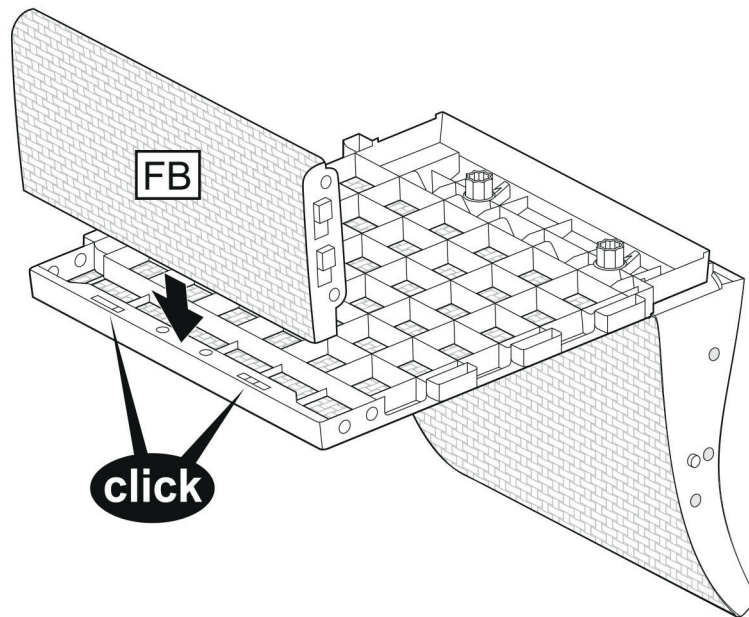

3

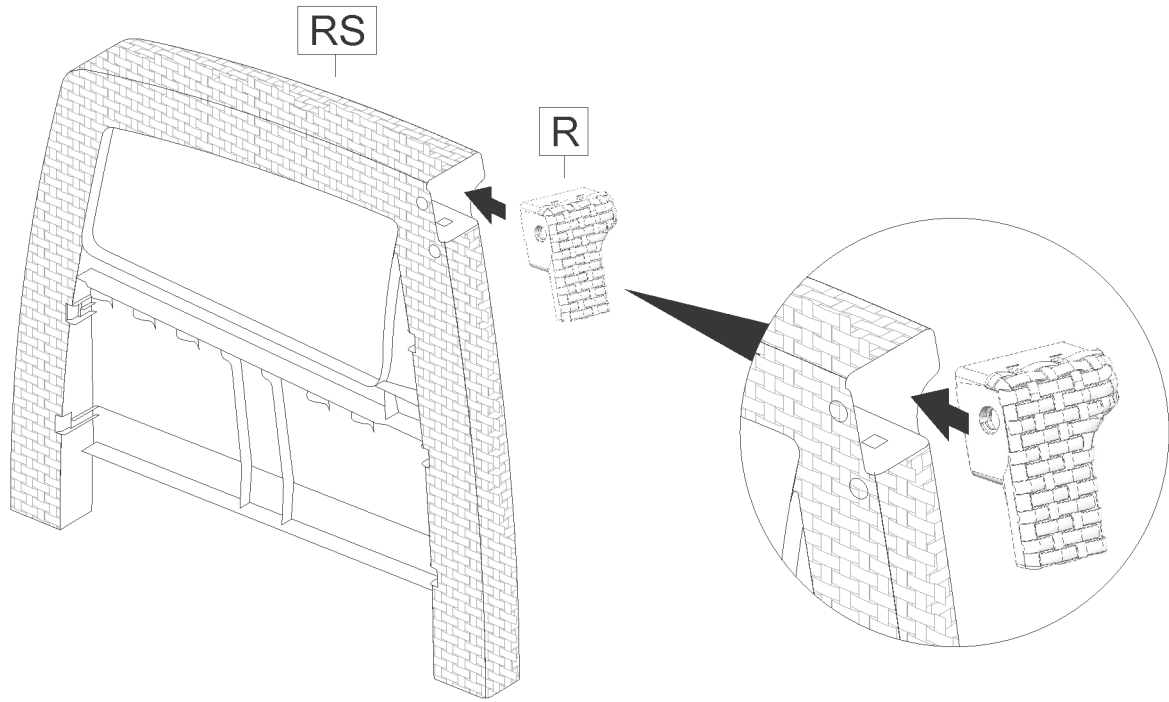

4

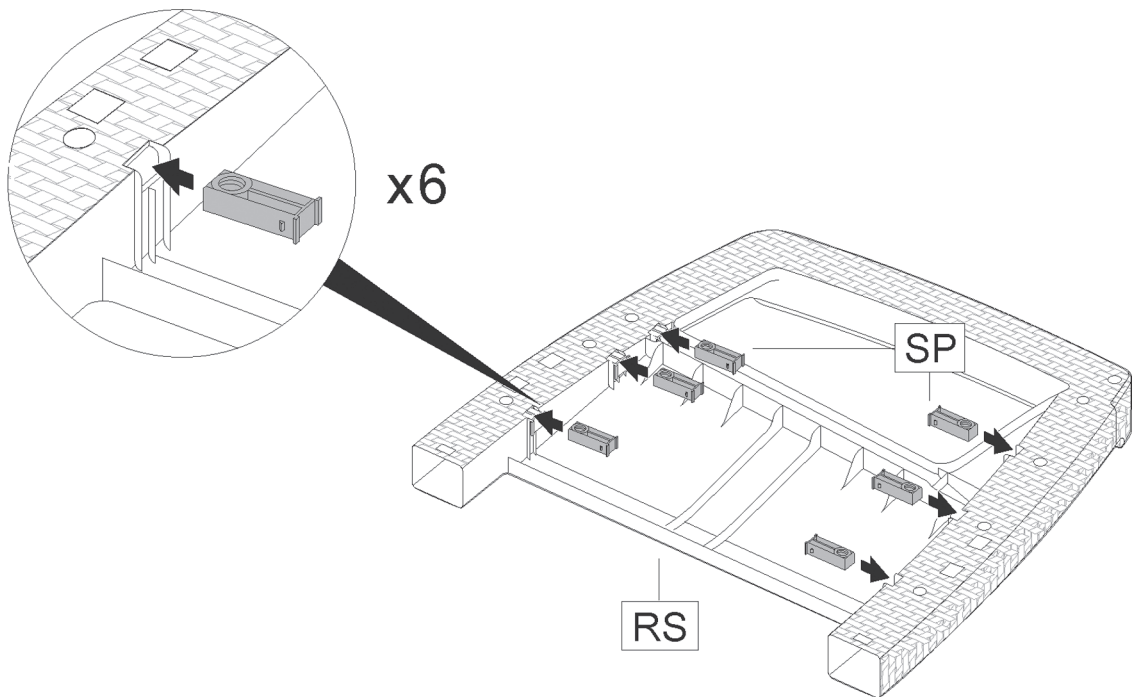
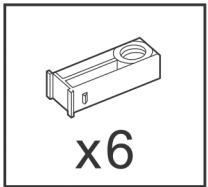

5

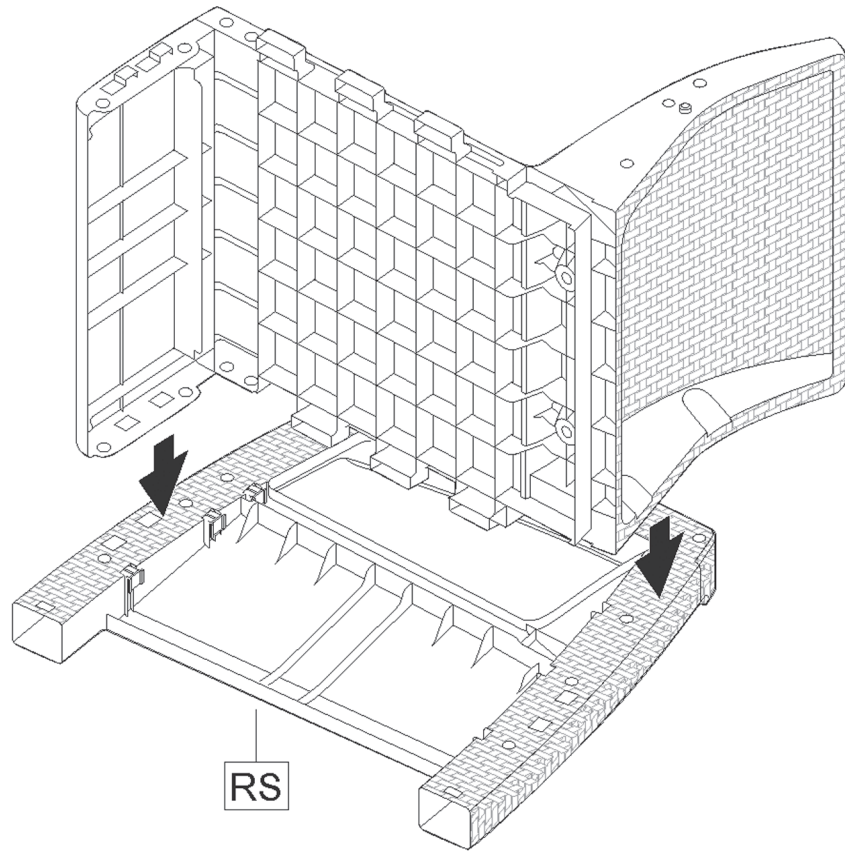

6

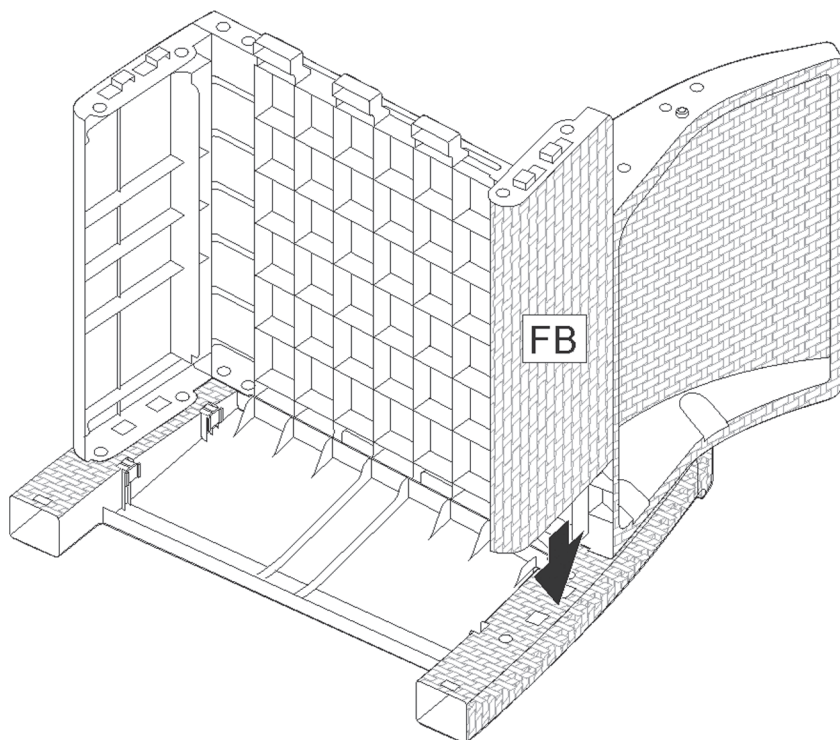

7

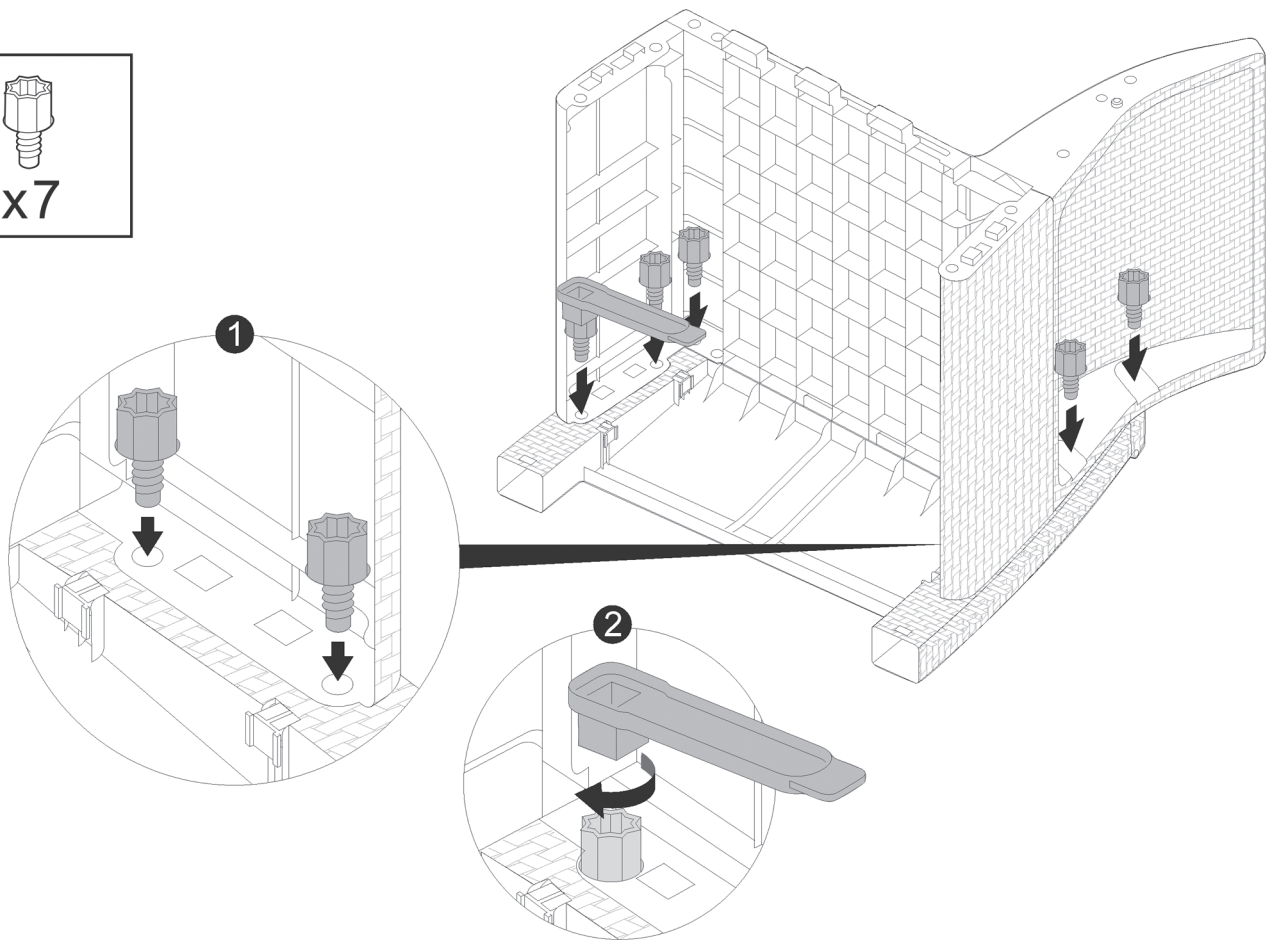
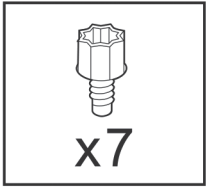

8

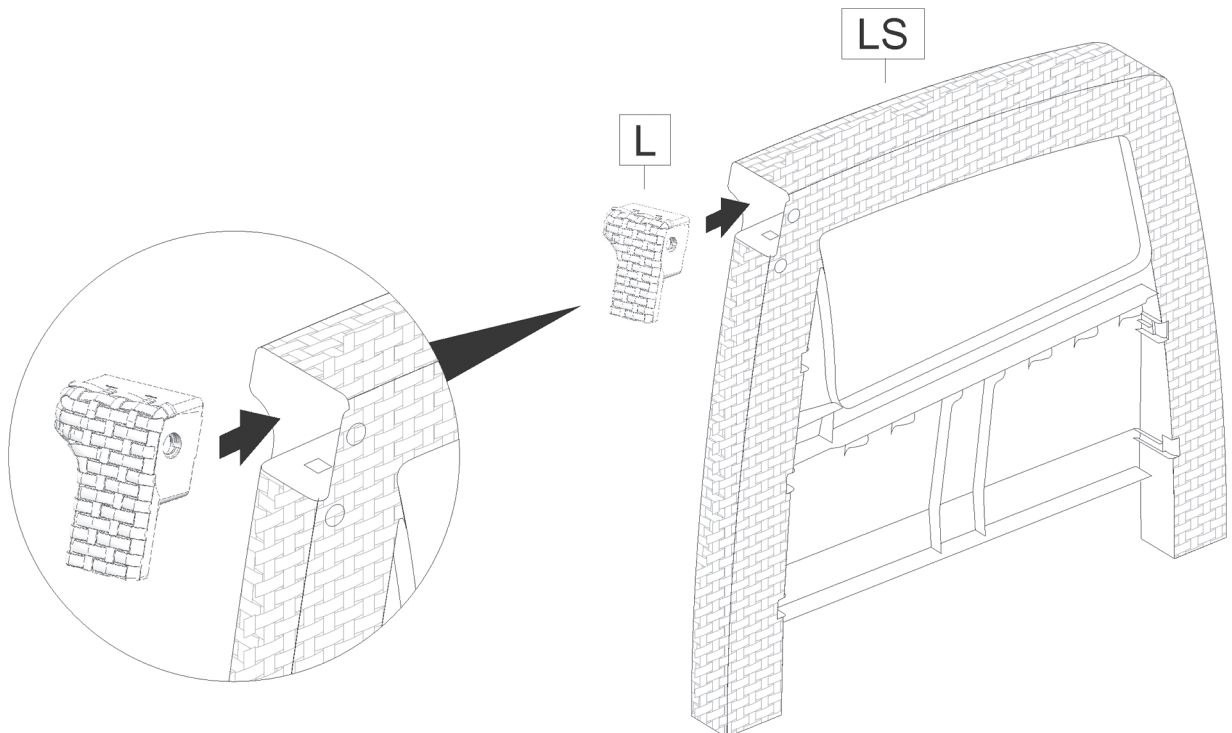

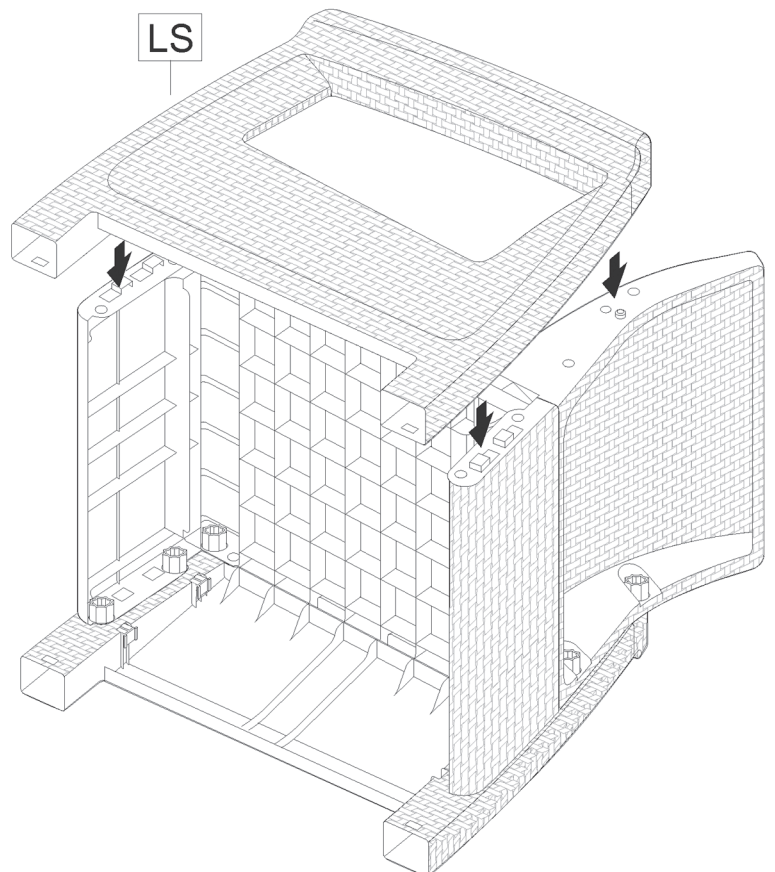
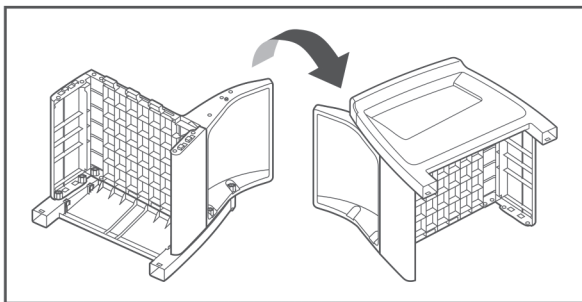
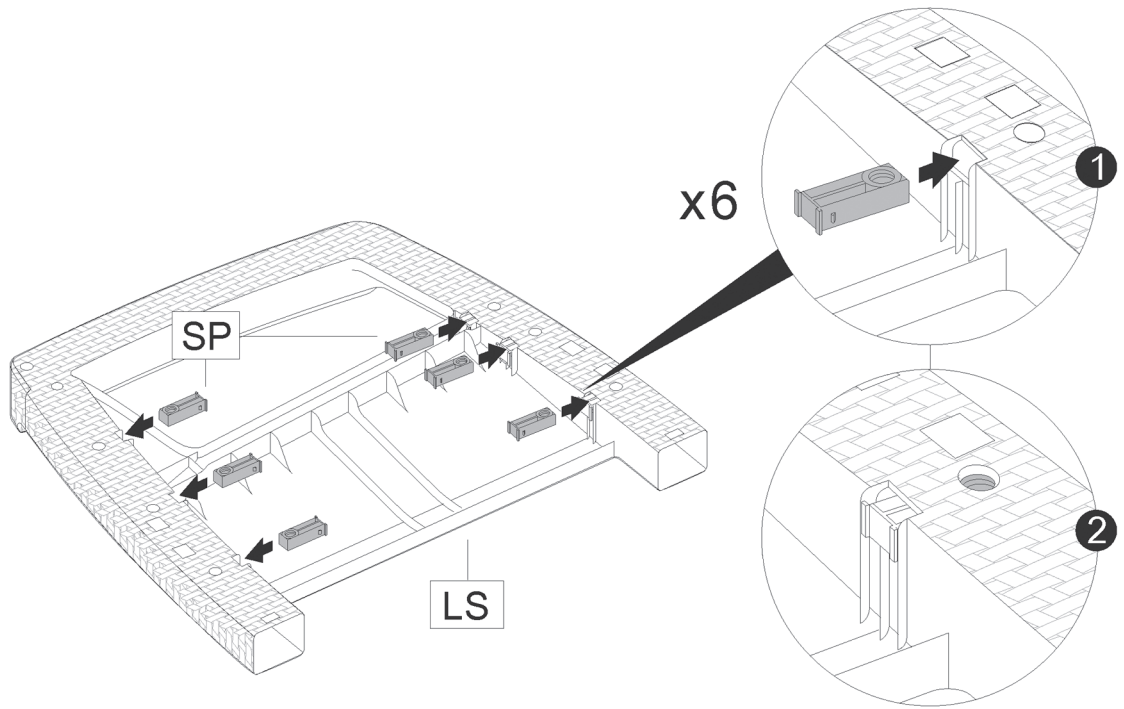
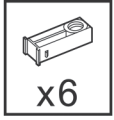

11

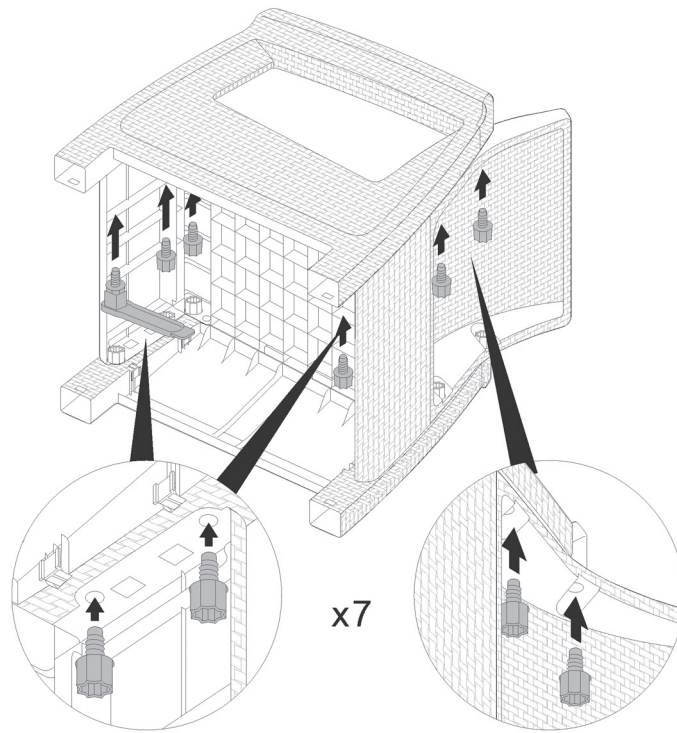

12

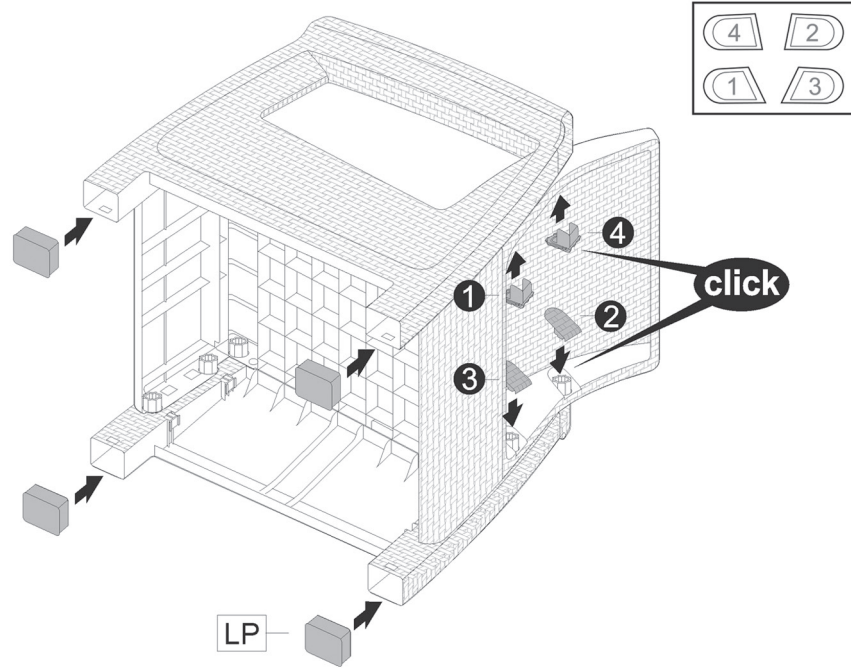
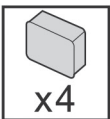

13

